



MY NAME IS HELIX



VINTAGEVIEW®
MOVING WINE STORAGE FORWARD

THE 2023 VINTAGEVIEW WINE RACK DESIGN GUIDE

THE NEXT REMARKABLE WINE RACK

BY VINTAGEVIEW



In the most minimalist way imaginable, the Helix Wine Rack hangs wine bottles off walls and posts to create distinctive custom wine storage systems, starting at just one bottle.

The helical design mimics one of nature's strongest structures, creating ultra-lightweight and incredibly durable bottle storage that starts at just 3-1/4" (8.5cm) in total depth. We believe it to be the world's most slim label-forward, wall-mounted wine rack.

Part of the all new R Series, the Helix Wine Rack* is available in two depths, two heights, and three compelling finishes to match VintageView's elegant wine storage collections.

Let's get you more acquainted with Helix...



vintageview.com/helix

*Design and utility patents pending internationally.

ANATOMY OF A HELIX WINE RACK

- 1 Left and right facing storage allows for double capacity
- 2 Elegant curves that angle bottles slightly above plane
- 3 Aluminum/steel alloy for optimal strength and material efficiency
- 4 Spacing for Champagne, Bordeaux, and Burgundy wine bottles (750ml)
- 5 Magnum storage (single-depth only)
- 6 Stackable 5" or 15" heights available
- 7 Left or Right bottle direction options
- 8 Remarkable finish options (Golden Bronze, Matte Black, or Cool Gray)
- 9 Installs direct to drywall or wood surfaces
- 10 Installs direct to a Post for floor-to-ceiling mounting
- 11 International design and utility patents pending

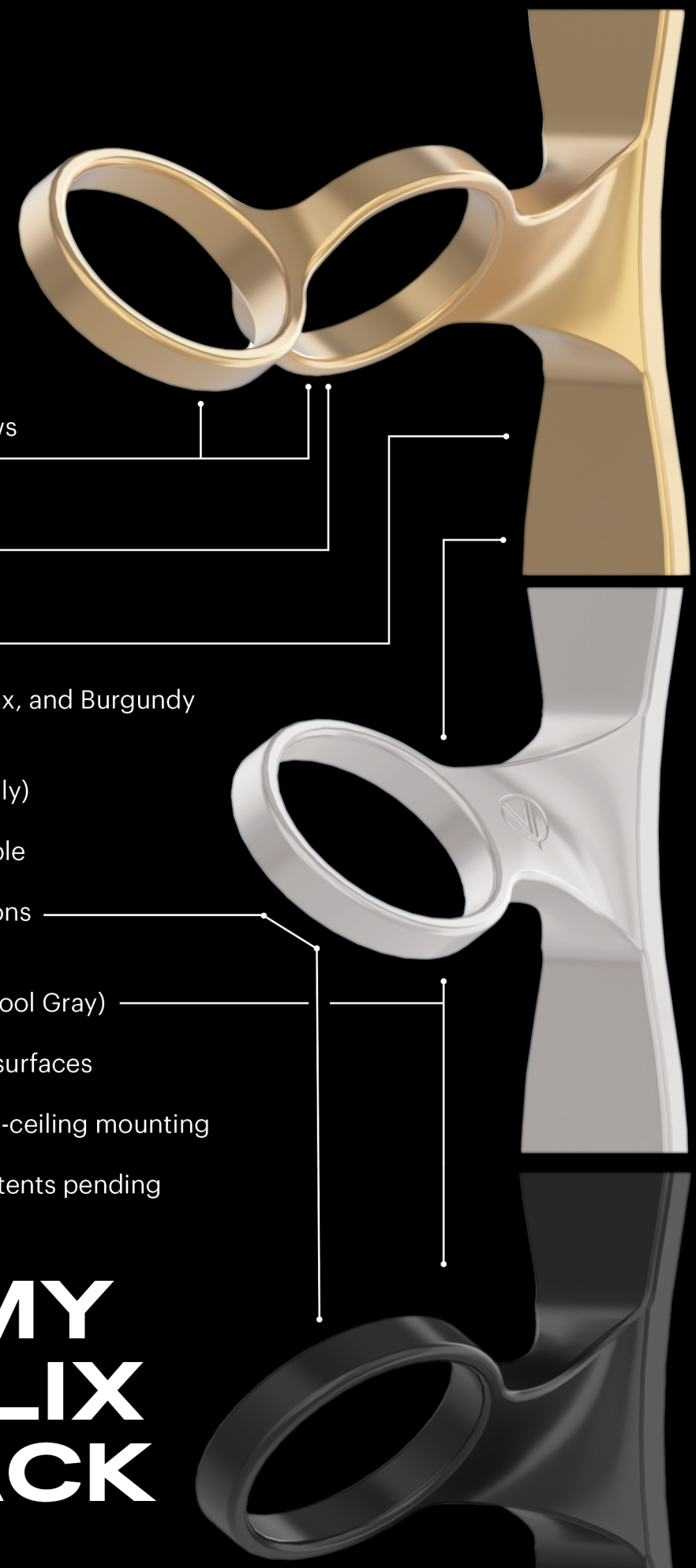

Helix is the result of a two-year process working with an esteemed industrial designer. Our goal: Bring label forward to the next level.

FOCAL POINT

Take this example. See how the dual bottle version of Helix provides both a unique visual from afar, but also adds texture with rotating bottle depths?



Helix Single and Dual Wine Racks (p52) 72 Bottles • Matte Black • Concept • Design: VintageView • Rendering: Roberto Valenzuela

SHOWCASE

The New American Home 2023 in Las Vegas serves as the official launching point of our distinctive wine rack. Using its companion Post, we pop bottles in front of a textured wall and against glass.

See the final results: vintageview.com/tnah



Helix Single and Dual Wine Racks on R Series Posts (p52) 154 Bottles • Matte Black • Henderson, NV • Design: Luxus Design Build • Rendering: Roberto Valenzuela

RESERVE LUXURY WINE VAULT

Just off Fort Lauderdale Beach, this elegant wine storage concierge welcomes customers with an artful display of Helix as they pass into a climate-controlled vault that stores their most valuable vintages.

This is Helix's second official installation.



THE WORLD LEADER IN SOPHISTICATED WINE CELLAR SOLUTIONS

While Helix embodies the VintageView mission of creating the most elegant and useful tools for the modern wine room, it's just one of **5 innovative VintageView collections** beloved by the design/build community.

Since 2001, VintageView wine racks have served as the mark of sophistication. Our simple elegance remains unmatched with a variety of unique wine storage styles to meet the mood of your project.

Our 2023 Design Guide showcases dozens of unique wine cellar projects, organized by style: Contemporary, Transitional, and Traditional. Our goal is to provide the inspiration for remarkable wine rooms — then back the projects with stellar service and a quality promise that lasts a lifetime. Enjoy!

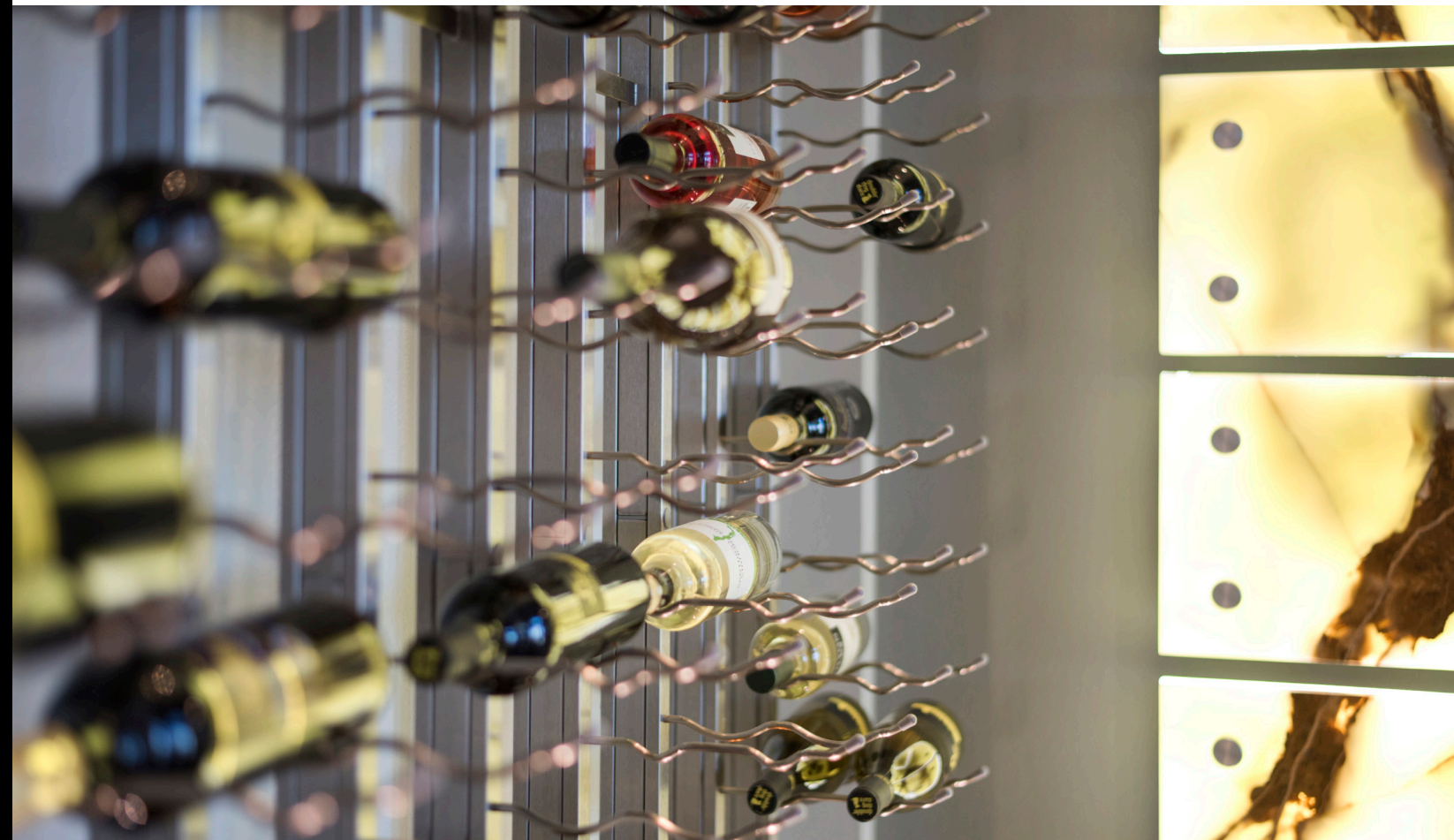

INSIDE:

Contemporary **8** Transitional **22** Traditional **36** Wine Rack Stats **50** Resources **60**

CONTEMPORARY

Pinterest-worthy images of remarkable, glass enclosed wine rooms continue to rise in prominence as the crisp mark of Contemporary takes its hold. Often found far from the cellar, these wine rooms touch entertainment zones in tony real estate, toeing the line of form and function.

Top design firms relish the challenge of crafting safe wine storage in light-filled environments, pushing innovation at every turn.

Minimalist • Industrial • Eclectic

DONELLA CIRCLE

This elegant Bel Air wine cellar serves as the central feature of a floor designed for entertainment — and pushes the engineering envelope by mounting racking direct to the glass. Stylistic industrial features amplify the design.



Evolution Wine Wall (p54) + Vino Series Stemware (p53) 1,116 Bottles • Chrome/Matte Black
• Bel Air, CA • Photo: Noel Kleinman

MINIMALISM

Characterized by a clean approach, this growing section of wine cellar design connects with collectors focusing every bit on the space itself — and not just what fits in it.

GODDARD STREET

Staggered wine pegs create the right touch of chaos in an otherwise simple layout that ensures eyes are drawn to the artful collection behind glass.



Vino Pins (p53) 154 Bottles • Milled Aluminum • Overland Park, KS • Design: Kristen Ridler Design • Photo: Picture KC

Featuring a unique directional configuration, the wine bottle layout uses simplicity to pull the attention to the center. Probably where the best bottles hang.



SIMPLISTIC SYMMETRY

Helix Single and Dual Wine Racks (p52) 96 Bottles • Matte Black • Concept • Design: VintageView
• Rendering: Roberto Valenzuela

Naturally, minimalism can be a literal description of the wine storage capacity. These three examples show how a few wine racks can elevate a space and still inspire excitement. ◀



Regents Boulevard
W Series Wine Racks (p50) 30 Bottles • Matte Black • West Palm Beach, FL • Photo: Randy Tanner/Living Proof Real Estate Photography



Wood Duck Way • W Series Single (p50) 16 Bottles • Matte Black • Prosper, TX • Design/Photo: Ashley Fenoglio

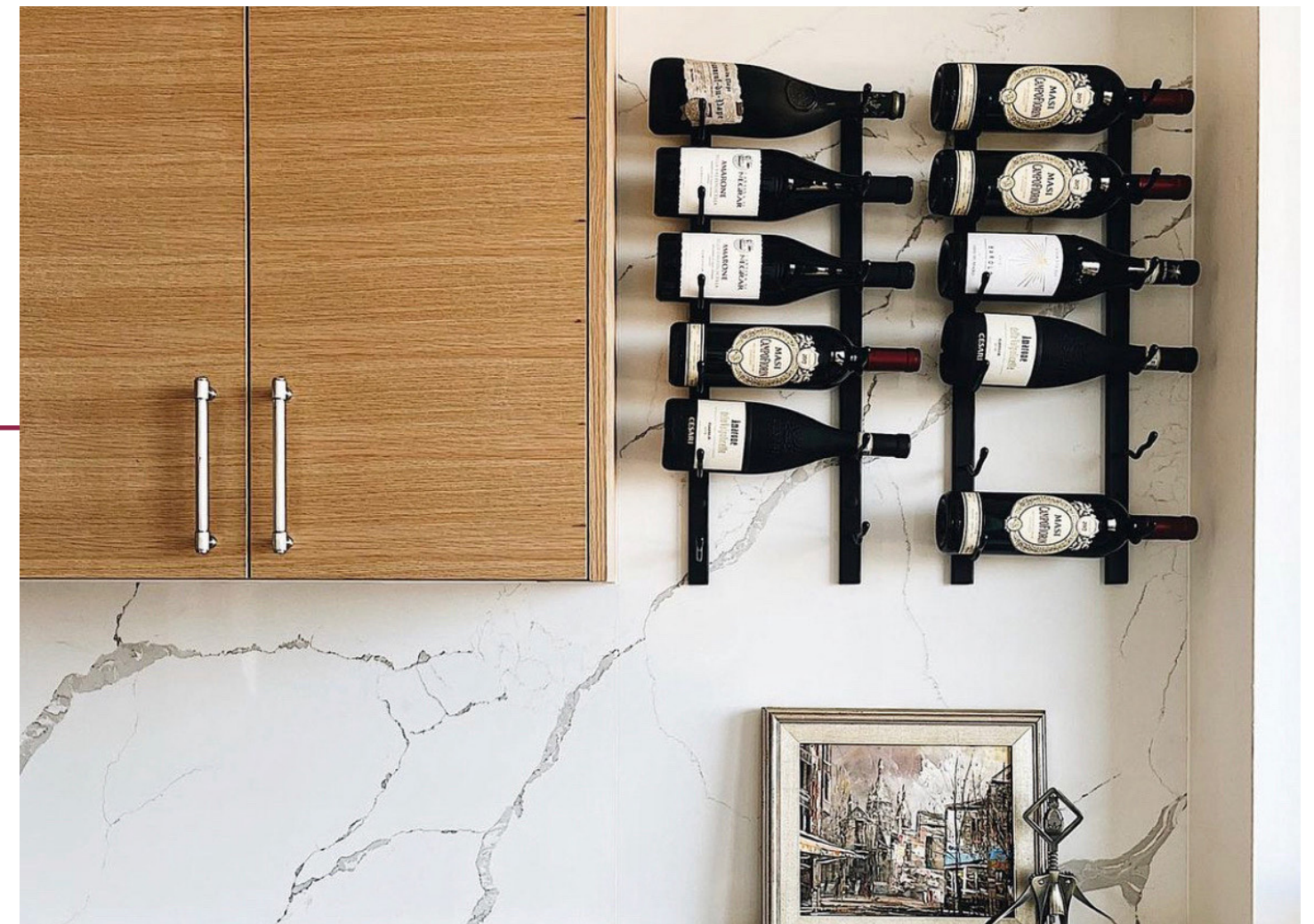

Grenville Society • W Series Wine Racks (p50) 12 Bottles • Matte Black • Toronto, ON • Design/Photo: Vija Kuras

INDUSTRIAL

Minimalism with a twist. Industrial style strips design down to the essentials, leaving exposed brick, concrete, metal, and more. It brings the focus squarely on the collection.

RIVER HOUSE

Floor-to-ceiling wine racking allows for smart placement of bottle storage in front of an exposed brick wall, framed by a steel glass enclosure. This cellar is the focal point of a beautiful modern home.



W Series Wine Rack Frame System (p50) 567 Bottles • Matte Black • Upper Saddle River, NJ • Design: Z+ Architects
• Photo: Cara Polizzi



Angling the Posts off plane allows for a distinctive, feathered aesthetic with floor-to-ceiling mounted storage.

INSPIRING ANGLE

Helix Single Wine Rack Post System (p52)
140 Bottles • Matte Black • Concept Room
• Design: VintageView Rendering: Roberto Valenzuela

Be it in a lounge-style winery or a perfect residential basement, interesting elements serve as elegant backdrops to the bottles in these two wine storage designs.



The Ordinary Fellow Winery
W Series Wine Rack Frame System (p50) 552 Bottles • Matte Black • Palisade, CO • Design: Winemaker Ben Parsons
• Photo: Lisa "Moose" Levy Kral

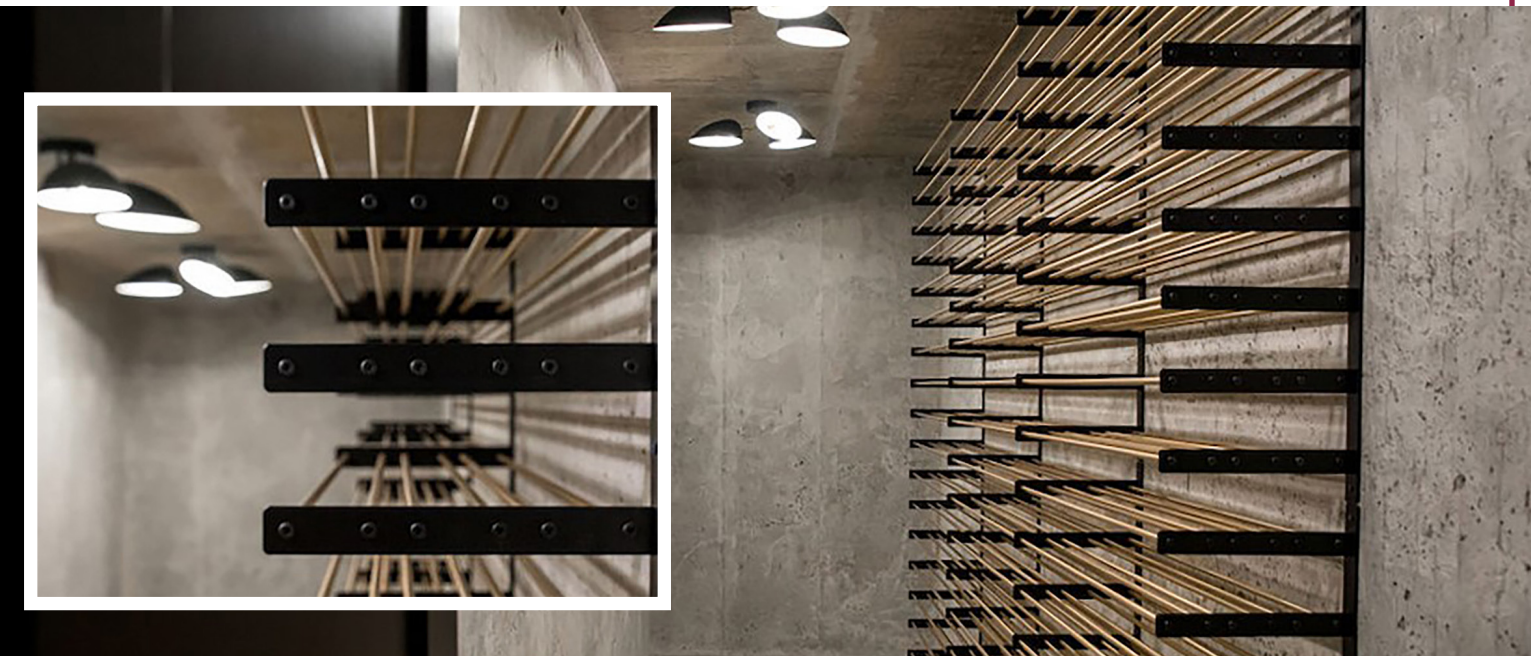

Banbury Lane
Evolution Wine Wall with Extensions (p54) 459 Bottles • Matte Black/Golden Bronze • Calgary, AB • Design/Photo: Veranda Homes

ECLECTIC

Far from homogeneous, eclectic storage showcases bold, risky design featuring texture, patterns, or both.



TRAILHEAD OASIS

A multi-storied wine room is the eye-catching feature in a refined space. Our eyes go directly to the natural wood door handle — after gazing at the wine racking for a moment.

Vino Pins (p53) 180 Bottles • Matte Black • Boulder, CO • Design: Cottonwood Custom Homes & HMH Architecture & Interiors • Photo: Kylie Fitts

DISTRICT DALLAS

It's difficult not to stare into this elegant wine cellar, with its back-lit, aqua blue onyx wall stealing the show. Unless you are into a most mod take on bull horns.



Vino Rails Post System (p53) 372 Bottles • Matte Black • Addison, TX • Design/Photo: District Restaurant Group

Color and patterns are royalty in two elegant wine spaces providing each homeowner a talking point when grabbing the next bottle. ◀



Ellison Avenue
Evolution Wine Rods (p57) 20 Bottles • Matte Black • Omaha, NE • Design: Fe Fi Faux Studios • Photo: Sandra Lassley

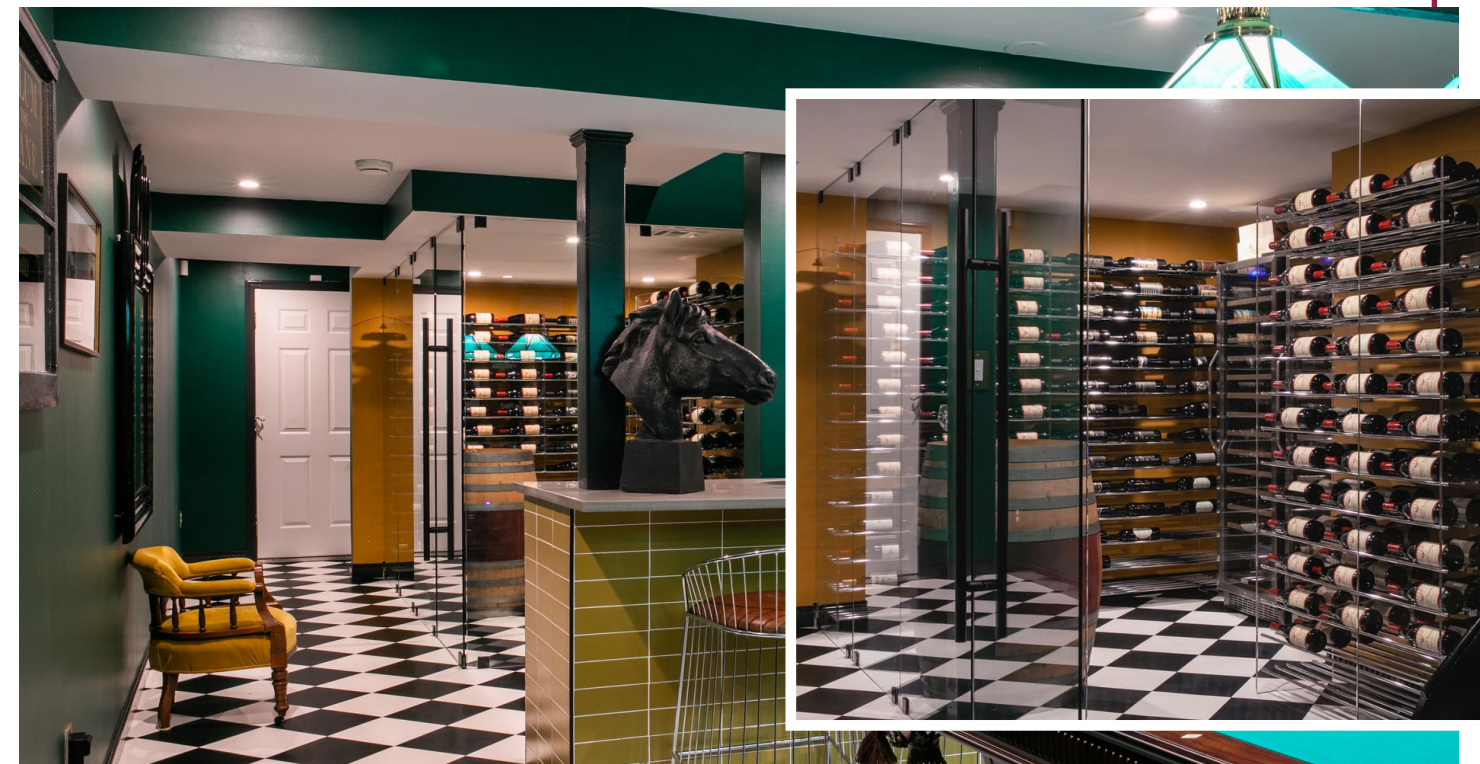

Old Wood Path
Evolution Wine Tower (p57) 504 Bottles • Chrome • Long Island, NY • Design: ReDesign Architects • Photo: Conor Harrigan

DESIGN CASE STUDY

SERIAL WINES TASTING LOUNGE | PASO ROBLES, CA

John Anthony Truchard (JaM Cellars, Weather Wines, namesake John Anthony) opened the Serial Wines Tasting Lounge in early 2022, consulting with trusted California designer Richard Von Saal to reimagine what's possible for the Paso tasting experience.

DESIGN CHALLENGE

The space needed to be bold, but also feel natural to Paso Robles, a town and region that celebrates its low-key authentic vibe that is a 180-degree stylistic turn from the renowned Napa Valley.



THE SOLUTION

The goal was to create a seductive space — both mysterious and inviting — to serve opulent, yet approachable wines sourced from the distinct Paso growing regions.

To achieve this, Von Saal custom-fabricated 80% of the furnishings to ensure a cohesive feel from the moment guests enter the patio, back through the narrow space to the cellar.

DESIGN APPROACH

One of the first steps Von Saal and his team take when designing a winery tasting room is to start with the most basic element: the actual wine. "I always taste the wines before I create the space," he says. "It has a lot to do with how the space moves."



vintageview.com/case-studies

Serial Wines • W Series Wine Rack Frame System (p50) 684 Bottles • Matte Black • Paso Robles, CA • Design: Richard Von Saal
Photo: Dusty Jenkins

TRANSITIONAL

Melding new and timeless aesthetics creates a cohesive design that speaks to a wide audience — perfect for the wine room in homes and commercial properties that embody the style throughout.

Modern Farmhouse • Mid-Century Modern • Bauhaus

HANDSOME STORAGE

Maintaining a balance between the two extremes of rustic and sleek, this home cabinet is a sophisticated example of Transitional's distinctive calling cards. Structured millwork, mixed textures, and raw materials create the perfect equilibrium of old and new.



MODERN FARMHOUSE

This fresh farmhouse style pulls in the classic countryside, adding modern touches such as bold lines, neutral color schemes, and untreated materials. The end result: warm and inviting spaces perfect for entertaining, especially when an upscale wine area is nearby.

SHADOW LAWN DRIVE

Warmth, natural light, and clever color scheme create an inviting atmosphere in this entertaining room anchored by an inspiring, glass-enclosed wine bar.



W Series Wine Rack Frame System (p50) 120 Bottles • Matte Black • Fanwood, NJ • Design: Ellie Mroz • Build: Michael Roberts Construction • Photo: Vic Wahby



LONGWOOD DRIVE

A wine wall is a feature that can greatly enhance the atmosphere of a tasting room. It adds a unique and personal touch to the space, and can contribute to the overall feeling of sophistication.

Vino Pins (p53) 183 Bottles • Matte Black • Bethesda, MD • Design: Julie Geyer Studio • Photo: Jenn Verrier

Even with the word “farmhouse” included in its name, there is plenty of room for innovative retail design in the category as shown in both bespoke retail and stylish winery environments.



Liquor Lodge
W Series Island Display Racks (p51) 2,500+ Bottles • Matte Black • Jasper, AB • Design: Laurie Griffiths Interior Design
• Photo: Tracey Jazmin



Medlock Ames
W Series Wine Racks (p50) 336 Bottles • Matte Black • Healdsburg, CA • Design: Will Wick • Photo: Joe Fletcher

MID-CENTURY MODERN

Seeing this style in a wine room would make Frank Lloyd Wright gush with pride (or switch to wine). While its sleek, clean, and curved lines offer enduring beauty, perhaps it's the homage to a classic era that has wine aficionados seeking out this design for their collections.

FERN PALM ROAD

The stylish wooden wall panels that frame a tasting shelf hearken back to glamorous 1950's design. The frameless glass at the entrance reminds us, however; that we are certainly living in the roaring '20s.



W Series Wine Racks (p50) 480 Bottles • Matte Black • Boca Raton, FL • Design: SRD Building Corp
• Photo: Randy Tanner, Living Proof Photography

ALEXANDRA BOULEVARD

The use of contradicting materials and textures in this see-through storage space gives it a sense of wonder and playful juxtaposition.



Evolution Wine Wall Post System (p54) 36 Bottles • Golden Bronze/Matte Black • Toronto, ON • Design: Iman Lalji
• Build: Sazeh Developments

Simple. Elegant. Timeless. The accents in these two rooms — from furniture to a bar cart — showcase the quintessential nature of Mid-Century Modern design.



Maroney Lane
W Series Wine Rack Frame System (p50) 252 Bottles • Matte Black • Pacific Palisades, CA • Photo: ZenHouse Collective



Bar Cart
Helix Dual Wine Racks (p52) 28 Bottles • Matte Black • Concept Room • Rendering: Roberto Valenzuela



This marvelous reno sits adjacent to the stunning Lake Sue just outside of Orlando, FL. The home, recently remodeled as the renovation half of the 2022 International Builders' Show, was designed to achieve National Green Building Standard "Emerald" certification, among other notable sustainable feats.



THE PROJECT

The massive single-story home occupies a sprawling 6,993 sq. ft. of living space.

The remarkable refresh kept the original design at its core and includes a framed glass-enclosed, conditioned wine room. Tucked behind the main entertaining area, it adds a hidden element of beauty and function to the home.

THE CHALLENGE

The space allotted for wine storage was perhaps the only place in the home it could fit. It was just 50" (127cm) in total width, creating a challenge to allow for maximum bottle capacity, functionality, and beauty.

THE SOLUTION

The Evolution Low Profile racking system fit the bill perfectly. We worked with Designer Trade Services to specify a one-bottle depth rack on one side and a triple-bottle version (11" in depth) opposite to align with the width of the door and accompanying glass walls on either side.

ENHANCEMENTS

Designer Trade Services custom built a marble and wood bar in the back of the room for liquor and other storage. They partnered with Maiden Steel to create the built-to-fit steel-framed glass door for a stunning entrance to the room that preserves the integrity of the environment inside.

BAUHAUS

With a focus on craftsmanship, efficiency, and a rejection of ornamentation, Bauhaus finds its home in the wine cellar with straight-to-the-point design. Look for artful accents such as furniture that emphasize functionality. The classic form-follows-function experience, so to speak.



Clean. Simple. Elegant. All with a pop of style in the form of the art selection that borders the wine room here.

BEACH HOUSE

W Series Wine Rack (p50) 378 Bottles • Brushed Nickel • Fort Lauderdale, FL • Photo: Randy Tanner, Living Proof Photography

THEATER DRIVE

The Presentation Row itself is a great representation of Bauhaus principles. In this inspiring example, they are stacked in waterfall style, creating a bold, uniform aesthetic.

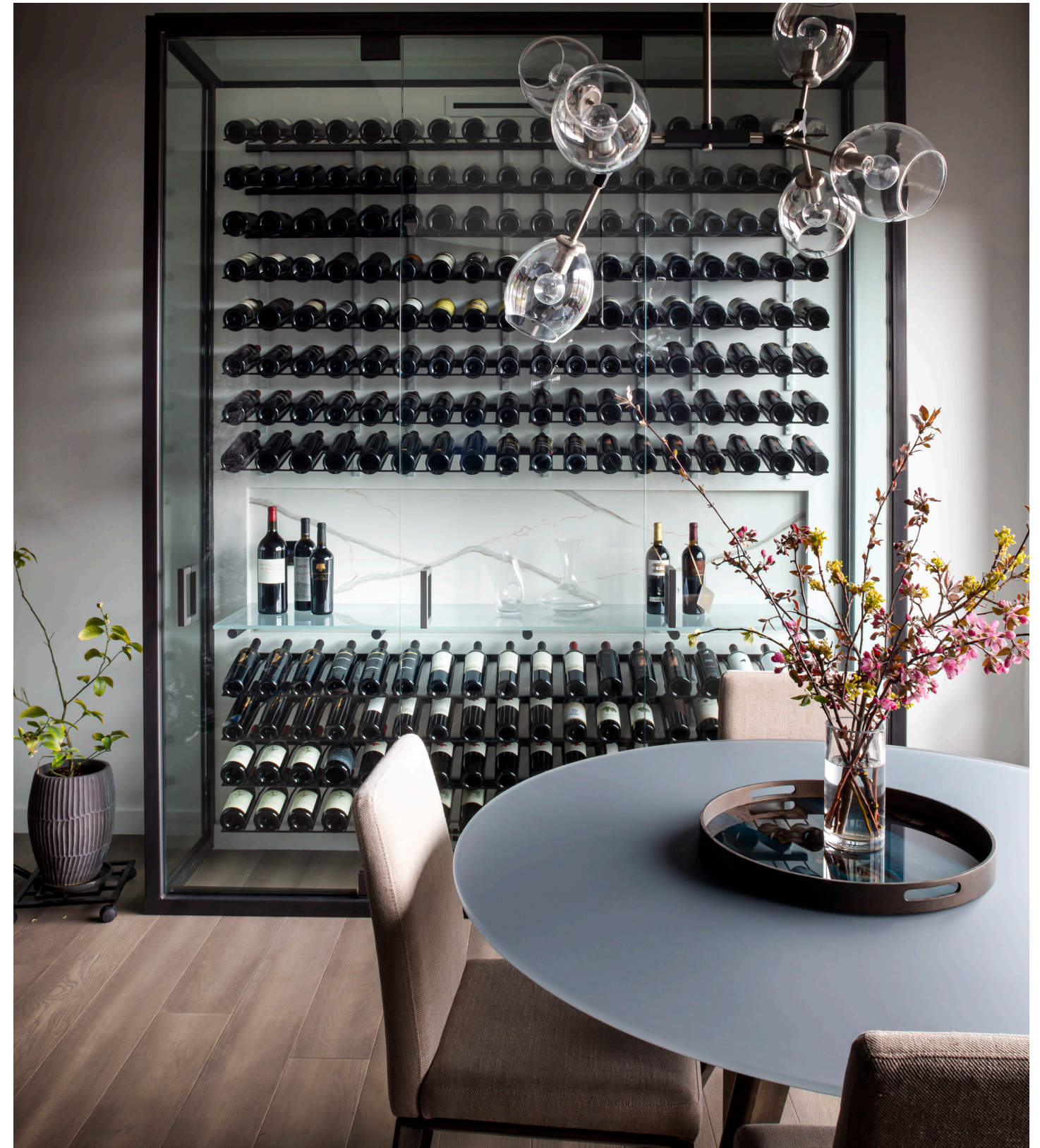

W Series Presentation Row (p50) 216 Bottles • Matte Black • Bend, OR • Design: Buffalo Ridge Builders

Displays large and small can showcase the haute design of Bauhaus.
Like these two examples. ←



Madison Club Residence

Vino Rails (p53) + W Series Wine Rack Frame System (p50) 261 Bottles • Milled Aluminum & Brushed Nickel
• La Quinta, CA • Design: Advanced Woodwork



Bauhaus Helix Render • Helix Dual Wine Rack (p52) 24 Bottles • Golden Bronze • Concept Room
• Rendering: Roberto Valenzuela

Q&A DESIGNER IMAN LALJI

Luxury has moved into the wine cellar. Helping break from the time-honored wooden aesthetics, metal racking is trending with the help of Contemporary influence.

Iman Lalji, of Toronto-based Designed by Iman, makes waves by injecting her innovative design prowess into every aspect of her practice. Her calling card is mixing unexpected textures, which is often the skill set her clients most seek.

Lalji's most common design feature? VintageView. [See (p28) for an example.]

VintageView: Tell us how you got to this point in your career.

Iman Lalji: I started my career in Calgary doing pre-construction sales, but I've always had a love for interior design since I was a child. I ended up moving to Toronto in 2012, and it was an opportunity to reinvent myself.

VV: What (or who) drew you to the design/build sphere?

IL: From an early age I would ask my mom to help me design my room in a Little Mermaid theme, from drapes to bedding — it was all matchy-matchy. I think having family members who are in real estate made me appreciate the functionality of spaces.

VV: What is your approach to your practice?

IL: [I aim to make] sure a room is functional and pretty, [while ensuring that] each piece is unique. The end result should feel curated rather than staged.

VV: Where do you see the industry going in the future?

IL: Design will continue to get more intricate and detailed, and most of all will be expected to be "instagram-able."

VV: What is the best piece of design advice you've received?

IL: If you spend a bit more to do it right, you'll never regret it!



TRADITIONAL

Traditional design is often misunderstood, perhaps even considered dated. But the remarkable qualities of this style mixed with a new way of creating wine displays allows for results that are uniquely relevant today.

Inspired by the 18th and 19th centuries, Traditional incorporates elements from Old World Europe, a perfect source of inspiration for wine cellars. Calling cards of this segment include dark, warm tones, and heavy, ornate adornments.

Rustic • Colonial • Neoclassic



W Series Presentation Rows on IDR Uprights (p50) 252 Bottles • Matte Black • Aspen, CO

MOUNTAIN LIVING

Surrounded by the warmth of wood and stone walls, a unique take on Presentation Row configuration stores each bottle in modern, sleek, and inspiring label-forward fashion. Mountain luxury at its finest.



• Design: Charles Cunniffe Architects • Photo: David O. Marlow

RUSTIC

Rustic is a natural progression of Traditional, letting time (literal or figurative) weather the decor that is often heavily wooded and natural. It's often expected in cellar design, but the addition of design firms and metal racking has elevated the category.

OFF STONE

Here, a few pops of metal (in the form of innovative wine pegs) create a focal point for a custom wood cellar allowing bottles to jump off the stone and appear to be floating.



Vino Pins (p53) 17 Bottles • Matte Black • Auburn, AL • Design/Photo: Linda Liebenow



WINN RESIDENCE

Playing off of the natural elements such as the exposed timber beams, this inspiring under-the-stairs cellar creates an open and inviting space. Wine pegs bring bottles off the wall in Traditional cork-forward fashion, but the simplistic design is anything but expected.

Vino Rails (p53) 42 Bottles • Matte Black • Marmora, ON • Design/Photo: Retreat Homes



HOTEL LE SAINT PAUL

This modern renovation turned a historic, medieval era cave into the ultimate private tasting room in this bespoke French hotel. Using our innovative (and patent-pending) Post system allowed the preservation of the delicate stone wall structure.

Vino Series Post Wine Rack System (p53) 534 Bottles • Matte Black • Saint-Paul-de-Vence, FR • Design: VintageView France • Photo: Martin Ayotte

COLONIAL

Inspired by 18th century European country homes, this simple, elegant, and minimal style has found a perfect place in wine storage. Often located in main floor living, the use of hardwood floors, patterned trim, and ornamental colors provide the perfect frame for decorative wine racking.

ORNATE STAIRCASE

Picture heading down the stairs into a beautiful basement remodel and finding *this* after the bottom step. The racking, framed by beautiful trim work, highlights the vino.



Helix Wine Rack (p52) 50 Bottles • Matte Black • Concept • Design: VintageView • Rendering: Roberto Valenzuela

HAPPY VALLEY

The paneled glass and black trim, combined with a wine ladder, sophisticated racking, and wood paneling all play on Colonial elegance here.



W Series Wine Racks (p50) 336 Bottles • Matte Black • Pleasanton, CA • Design: Ridgecrest Designs • Photo: Ridgecrest Designs



FORMAL DINING

Faux wood wallpaper creates the perfect backdrop for a compelling wine wall, giving the illusion of warmth while bottles magically float off the surface.

Vino Pins (p53) 33 Bottles • Matte Black • Upper Saddle River, NJ • Design/Photo: Spaces of Distinction

WILLOW PLACE

Enhancing the beautiful crown molding, patterned trim, and wooden accents throughout, this cellar is tucked behind wood-framed glass doors, allowing it to blend perfectly. When guests arrive, however, switching on the LEDs turns subtlety on its head.



W Series Wine Racks (p50) 318 Bottles • Matte Black • Manotick, ON • Design: Capitol Cellars

NEOCLASSIC

Where glamor meets tradition. Neoclassic is compelling, sophisticated, and striking. The architectural details set the style apart, featuring eye-catching columns, crown molding, high ceilings, and spacious layouts. When wine storage finds its way to this period of design, the results are simply elegant.

SITTING ROOM

There's not a better place to sit with a glass than this tidy space that features intricate details in the decorative molding. The wine display is practically framed as art, don't you think?



Helix Dual Wine Rack (p52) 24 Bottles
• Golden Bronze • Concept Room
• Design: VintageView • Rendering:
Roberto Valenzuela

HOUSE OF BARLOW

Every detail of this formal sitting room showcases the elegance of Neoclassic. It's difficult to pick the most compelling design piece here, but the golden wine bottle pegs could be the answer. Elegant. Minimal.



Vino Pins (p53) 42 Bottles • Golden Bronze • Dublin, OH • Design: Gigi Melton/House of Barlow
• Photo: Natasha Anne Photography

AKIAU RESIDENCE

Symmetry is at the center of this dining room design with a glass wine cellar mirrored on each side of the dining table. High ceilings and tall curtains frame the room, giving into Neoclassic accents.



Evolution Wine Wall Post System (p54) 130 Bottles • Matte Black/Golden Bronze • Weston, FL • Design: Renata Sallowicz Design • Photo: Miranda Kruse/MissTakes

TRADITIONAL WINE CELLAR DESIGN CASE STUDY

STAVE CELLAR | SONOMA, CA

This Sonoma County home features one of the most beautiful, Old World wine cellars we have come across in the last 22 years of creating remarkable wine racking. It is the example that shows how far design standards have come in a most Old World setting.

THE PROJECT

More than 1,000 bottles call this impeccable cellar home in the heart of California wine country. Blending the best of modern sophistication in an otherwise Traditional space that pays homage to European wine culture. We call this the "Stave Cellar." Read on to see why.

THE CHALLENGE

Challenged with a unique client aesthetic: "somewhere between being within a whale's skeleton and the hull of a ship," designers were tasked with following the guidance and creating a special space out of this in-ground cellar.

THE SOLUTION

Reclaimed staves from oak barrels shape the cellar like a ship's hull and provide visual depth, while custom wood bins and display racking achieve bottle capacity requirements. An air of seduction is added with backlighting behind the staves on the wall and ceiling.



W Series Wine Racks (p50) 1,000+ Bottles • Matte Black
• Sonoma, CA • Design: Bevan + Associates in collaboration with
Wine Racks America.

W SERIES WINE RACK

The original label forward wine rack maintains its elite status among remarkable wine cellar design professionals.

SCAN FOR **BILT** 3D INSTRUCTIONS



POWERED BY **BILT INTELLIGENT INSTRUCTIONS**

W SERIES ISLAND DISPLAY RACK

The modern workhorse wine rack for bespoke retail design.



Minimal (single-bottle depth)

Height	Width	Bottles
4" (10.5cm)	13" (33cm)	1
1' (30.5cm)	13" (33cm)	3
2' (61cm)	13" (33cm)	6
3' (91.5cm)	13" (33cm)	9
4' (123cm)	13" (33cm)	12

Depth: 5-1/4" (13.5cm)

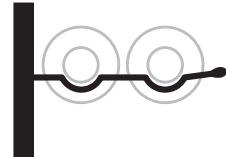

Balanced (double-bottle depth)

Height	Width	Bottles
4" (10.5cm)	13" (33cm)	2
1' (30.5cm)	13" (33cm)	6
2' (61cm)	13" (33cm)	12
3' (91.5cm)	13" (33cm)	18
4' (123cm)	13" (33cm)	24

Depth: 8-1/2" (22cm)



Max Capacity (triple-bottle depth)

Height	Width	Bottles
4" (10.5cm)	13" (33cm)	3
1' (30.5cm)	13" (33cm)	9
2' (61cm)	13" (33cm)	18
3' (91.5cm)	13" (33cm)	27
4' (123cm)	13" (33cm)	36

Depth: 12" (30.5cm)



Magnum Minimal (single-bottle depth)

Height	Width	Bottles
45" (114.5cm)	15" (38cm)	9

Depth: 5-1/4" (13.5cm)



Magnum Balanced (double-bottle depth)

Height	Width	Bottles
45" (114.5cm)	15" (38cm)	18

Depth: 10" (25.5cm)



Magnum Minimal (single-bottle depth)

Height	Width	Bottles
30" (76.5cm)	18" (46cm)+	4

Depth: 8" (20.5cm)

Floor-to-Ceiling Application:

The W Series Wine Rack Frame — cut-to-fit on site — comes in standard 10' (305cm), 12' (366cm), and 15' (457.5cm) heights for floor-to-ceiling installation.

Pro Grade Finishes



Matte Black



Cool Gray*



Brushed Nickel

Luxe Edition Finishes



Chrome Luxe



Golden Bronze Luxe



Gunmetal Luxe

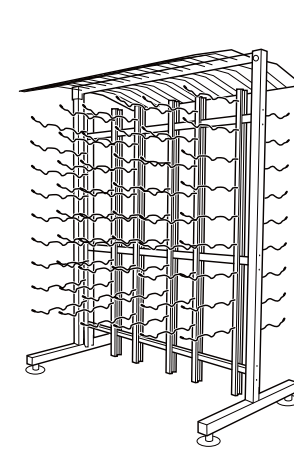

IDR 3*

	Width	Columns	Bottles
B	40 1/2"	3	180
2	79 1/2"	6	360
3	118 1/2"	9	540
4	157 1/2"	12	720

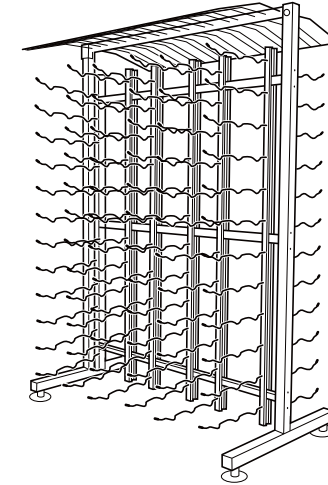

IDR 4*

	Width	Columns	Bottles
B	40 1/2"	3	234
2	79 1/2"	6	468
3	118 1/2"	9	702
4	157 1/2"	12	936

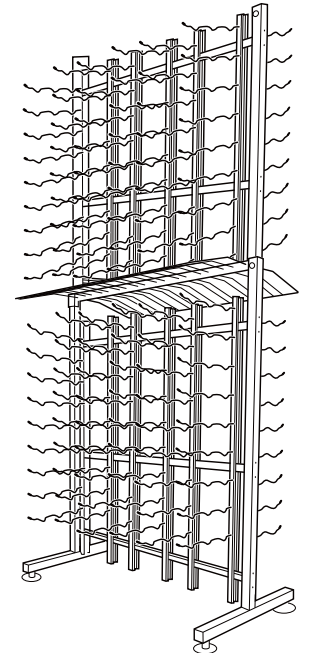

IDR 7**

	Width	Columns	Bottles
B	40 1/2"	3	288
2	79 1/2"	6	576
3	118 1/2"	9	864
4	157 1/2"	12	1152

* IDR 3s and 4s available in one-sided, half units ** IDR7s available in a 378-bottle XL configuration

Modular Extensions Available Extension kits allow for modular growth of any IDR racking option.

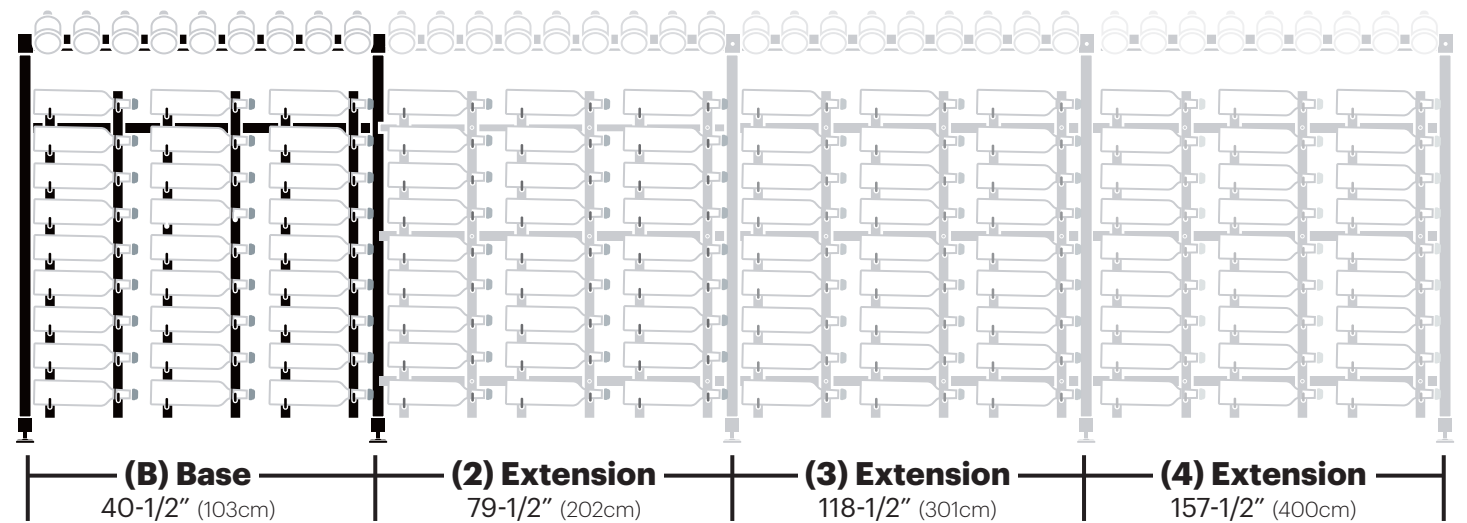

Finishes



Matte Black



Brushed Nickel

HELIX WINE RACK

Elegant, minimal wine racking that mimics one of the most efficient structures in nature.

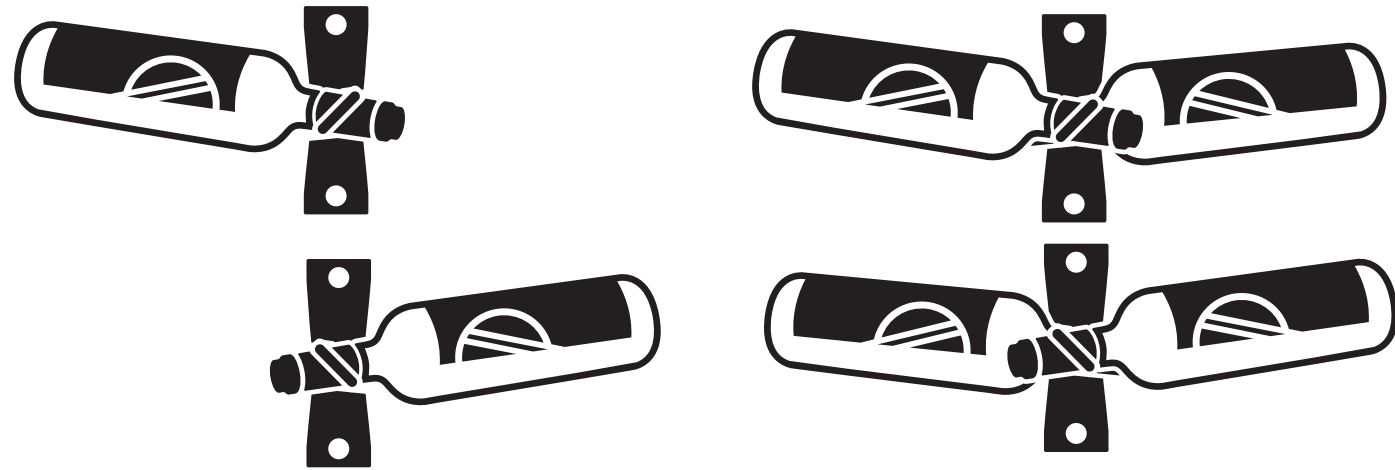

Minimal (single-bottle depth)
750ml or Mag bottles

Height	Width	Bottles
5" (13cm)	13" (33cm) 750ml	1
15" (38.5cm)	15" (38.5cm) Mag	3

Depth: 3 1/4" (8.5cm)

Configurations: Left, Right

Balanced (dual-bottle depth) 750ml bottles

Height	Width	Bottles
5" (13cm)	21" (53.5cm)	2
15" (38.5cm)	21" (53.5cm)	6

Depth: 5 1/4" (13.5cm)

Configurations: Standard, Mirror

Floor-to-Ceiling Application:
The R Series Helix Wine Rack and VINO Series Wine Rack Post systems — cut-to-fit on site — come in standard 5' (152.5cm), 10' (305cm), 12' (366cm), and 15' (457.5cm) heights for floor-to-ceiling installation.

Finishes



Matte Black



Cool Gray

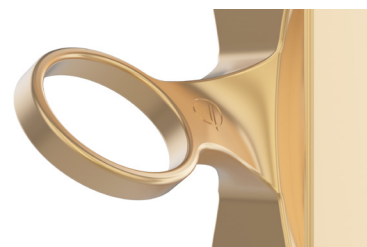

Golden Bronze

VINO SERIES

The most trusted peg system in the world offers sophistication, scalability, and confidence to install direct into drywall.



Minimal (single-bottle depth)
Standard or Magnum bottles

Height	Width
750ml 5" (13cm)	13" (33cm)
1.5L 6" (15.5cm)	15" (38.5cm)

Depth: 4" (10.5cm)
capacity: 1



Balanced (double-bottle depth)

Height	Width
5" (13cm)	13" (33cm)

Depth: 8" (20.5cm)
capacity: 2



Maximum (triple-bottle depth)

Height	Width
5" (13cm)	13" (33cm)

Depth: 12" (30.5cm)
capacity: 3

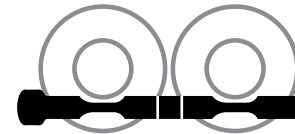

Magnum Balanced
(double-bottle depth)

Height	Width
6" (15.5cm)	14" (35.5cm)+

8-1/2" (21.5cm)
capacity: 2 (1.5L)



Cork Forward
(single-bottle depth)

Height	Width
5" (13cm)	3" (8cm)

Depth: 13" (33cm)
capacity: 1



Cork Forward Magnum
(single-bottle depth)

Height	Width
6" (15.5cm)	3 1/2" (9cm)

Depth: 15" (38.5cm)
capacity: 1 (1.5L)

one bottle

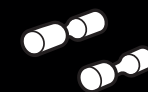

two bottles

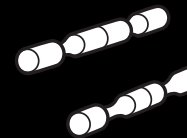

three bottles

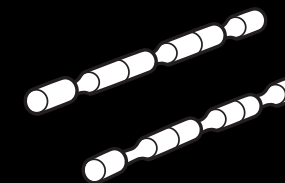

one bottle,
cork forward



add collars for drywall installation

Finishes

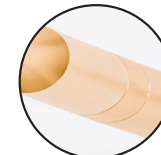

Golden Bronze

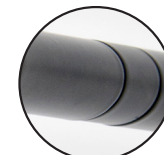

Matte Black

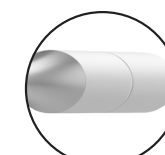

Cool Gray*



Gunmetal

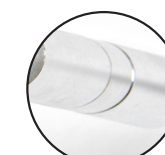

Aluminum

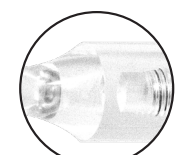

Acrylic

*special order; lead times apply

EVOLUTION WINE WALL

Industrial chic design that provides the most height, depth, and width options to scale to any custom needs.

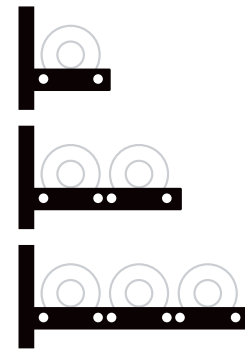
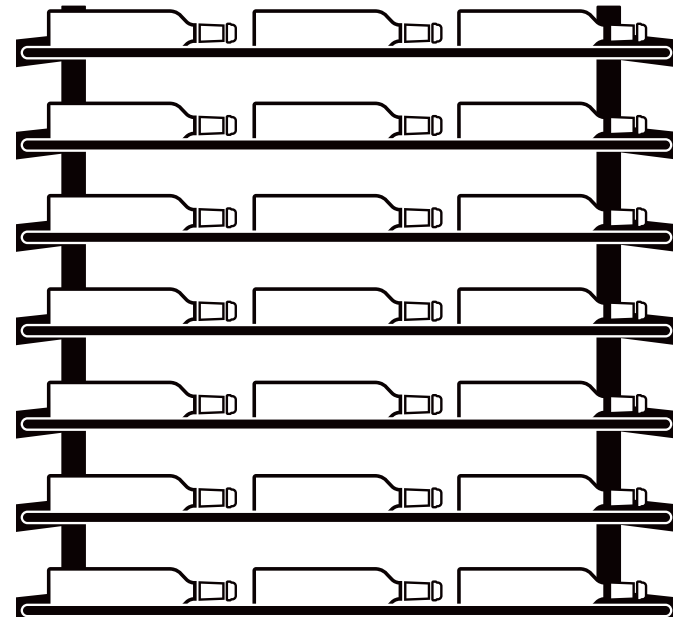

bottle depth options:

single 4 1/8" (10.5cm)

double 8 1/8" (21cm)

triple 12 1/8" (31cm)

Height	Depth	Width	Bottles
5"	1,2,3	1c,2c,3c	3, 6, 9,
15"	1,2,3	1c,2c,3c	9, 18, 27
30"	1,2,3	1c,2c,3c	18, 36, 54
45"	1,2,3	1c,2c,3c	27, 54, 81

EVOLUTION LOW PROFILE

A superior designed floor-to-ceiling wine rack that begins at an impossible 3" (8cm) of total depth.

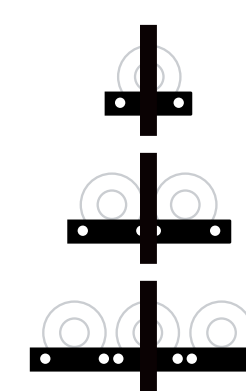
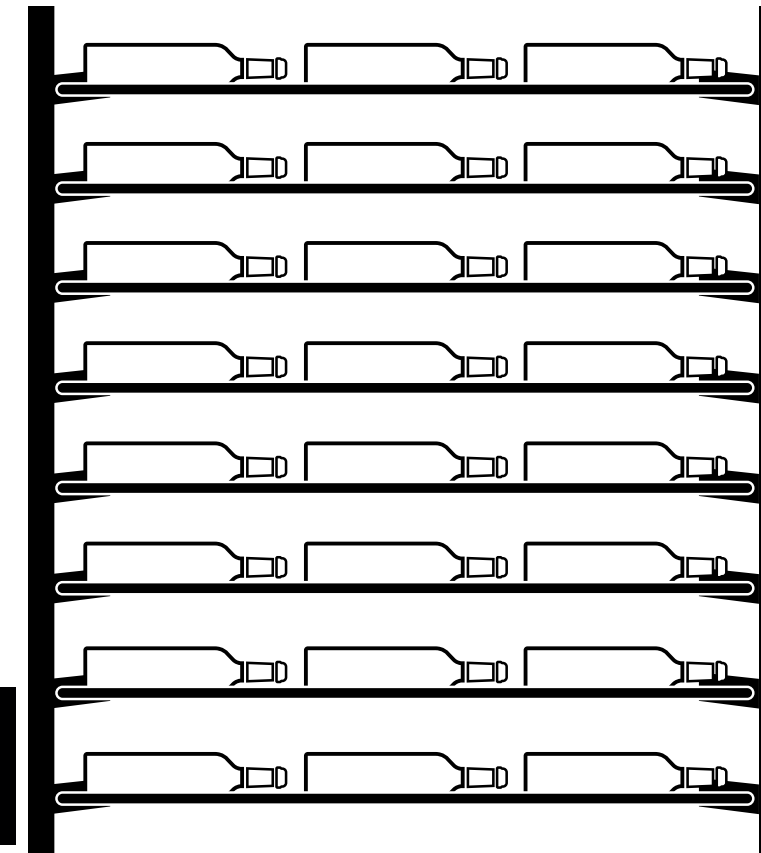

bottle depth options:

single: starting at 3" (8cm)

double: 7" (18cm)

triple: 11" (28cm)

Height	Depth	Width	Bottles
5'	1,2,3	1c,2c,3c	10 to 90
10'	1,2,3	1c,2c,3c	22 to 198
12'	1,2,3	1c,2c,3c	27 to 243
15'	1,2,3	1c,2c,3c	34 to 306

Floor-to-Ceiling Application: The Vino Series Wine Rack and Low Profile Post systems come in standard 5' (152.5cm), 10' (305cm), 12' (366cm), and 15' (457.5cm) heights for floor-to-ceiling installation.

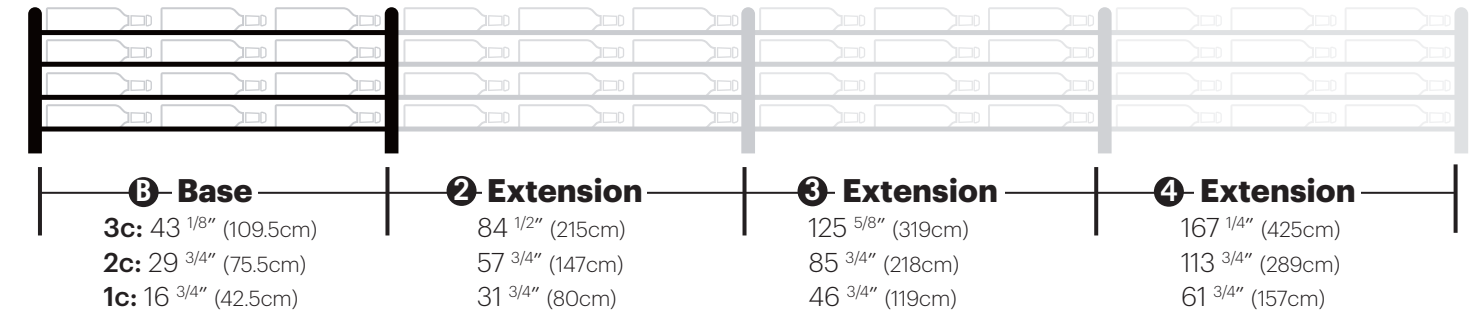
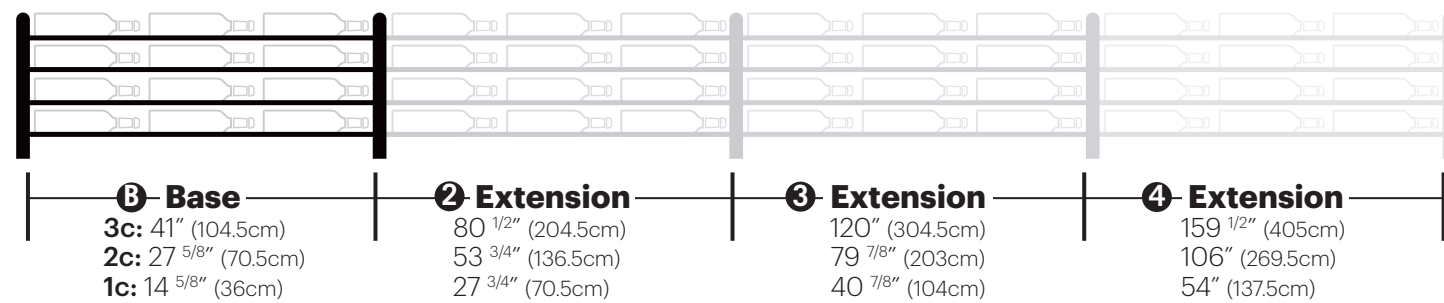

Finishes



Chrome/
Matte Black



Golden Bronze/
Matte Black



Cool Gray*



Matte Black

LOW PROFILE vs WINE WALL POST

Two remarkable Evolution floor-to-ceiling wine rack systems. Here's how to pick the best option for your project:

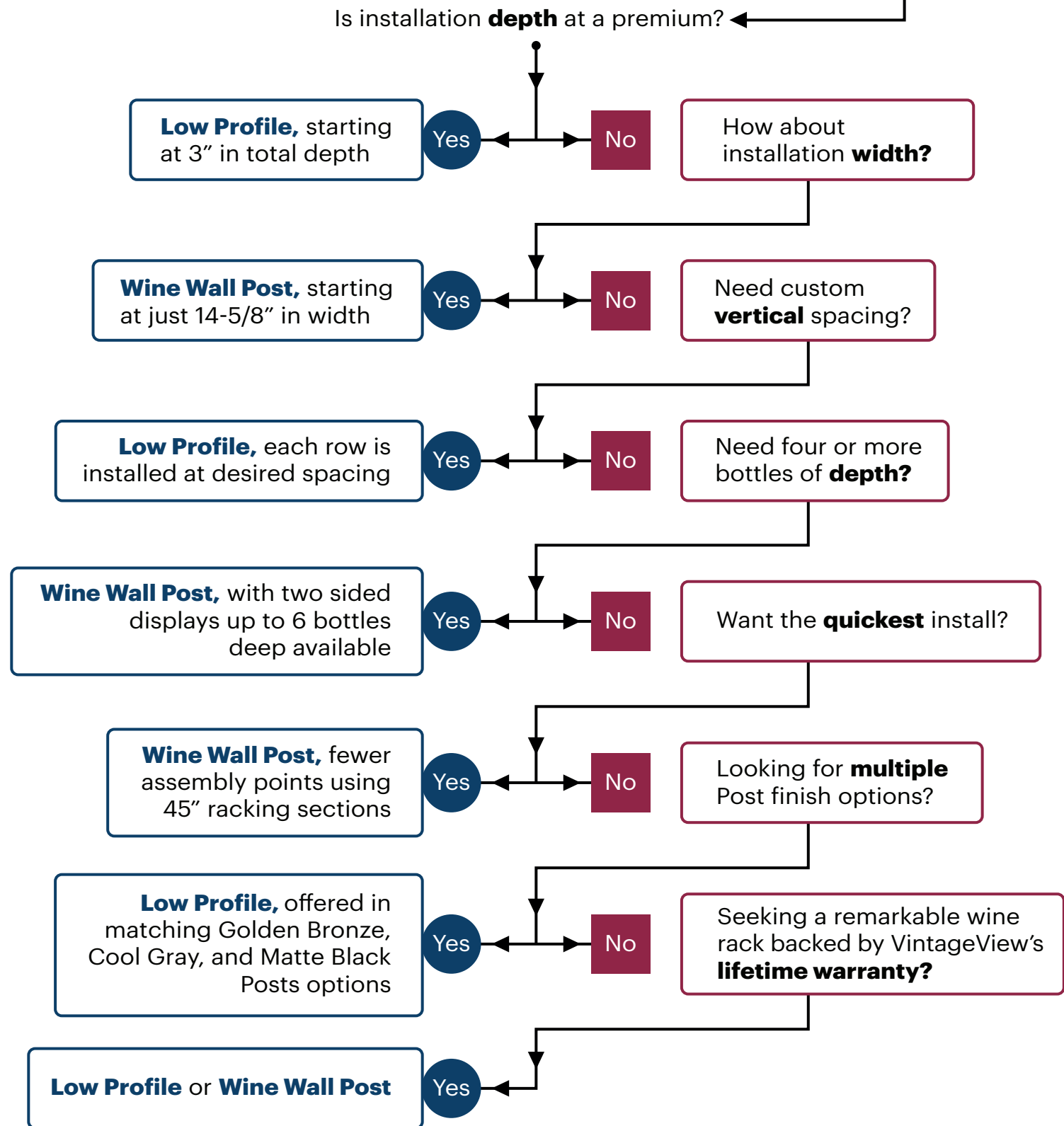

EVOLUTION WINE TOWER

Sophisticated minimalism blending steel and acrylic into beautiful freestanding wine storage.

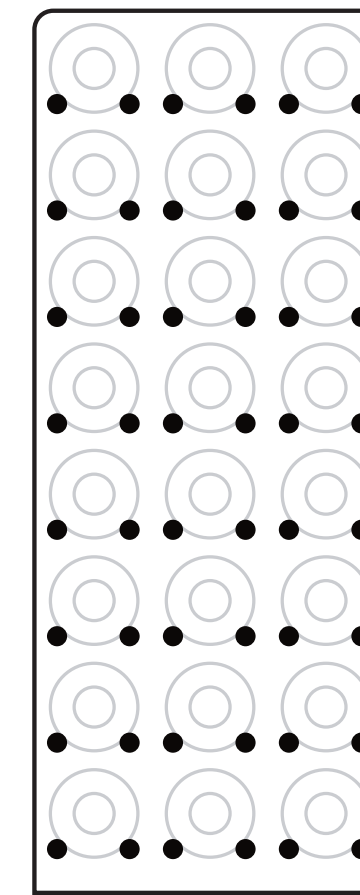

Wine Tower 47

Width	Cols	Btls
40 1/2" (103cm)	3	81
80 1/2" (204.5cm)	6	162
121 1/2" (309cm)	9	243
160 1/2" (408cm)	12	364

Wine Tower 72

Width	Cols	Btls
40 1/2" (103cm)	3	126
80 1/2" (204.5cm)	6	252
121 1/2" (309cm)	9	378
160 1/2" (408cm)	12	504

Wine Tower 92

Width	Cols	Btls
40 1/2" (103cm)	3	162
80 1/2" (204.5cm)	6	324
121 1/2" (309cm)	9	506
160 1/2" (408cm)	12	648

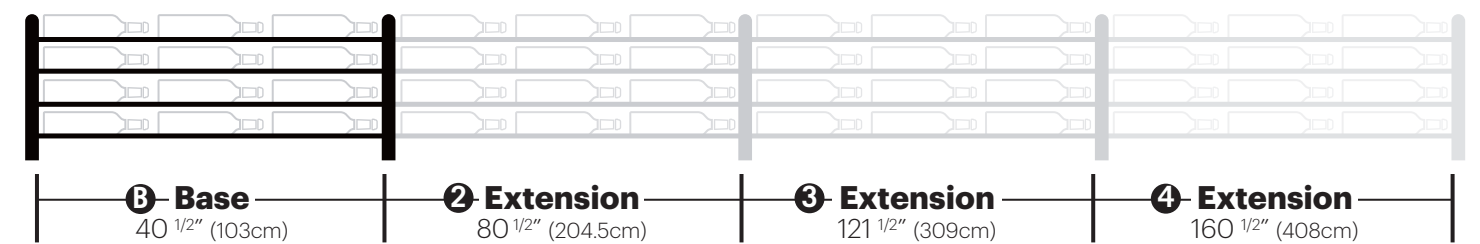

Finishes



Acrylic/
Matte Black

Acrylic/
Cool Gray*

Acrylic/
Golden Bronze

Acrylic/
Chrome

*special order; lead times apply

EVOLUTION ISLAND DISPLAY RACK

Designed for retail, but refined for upscale penthouse living.

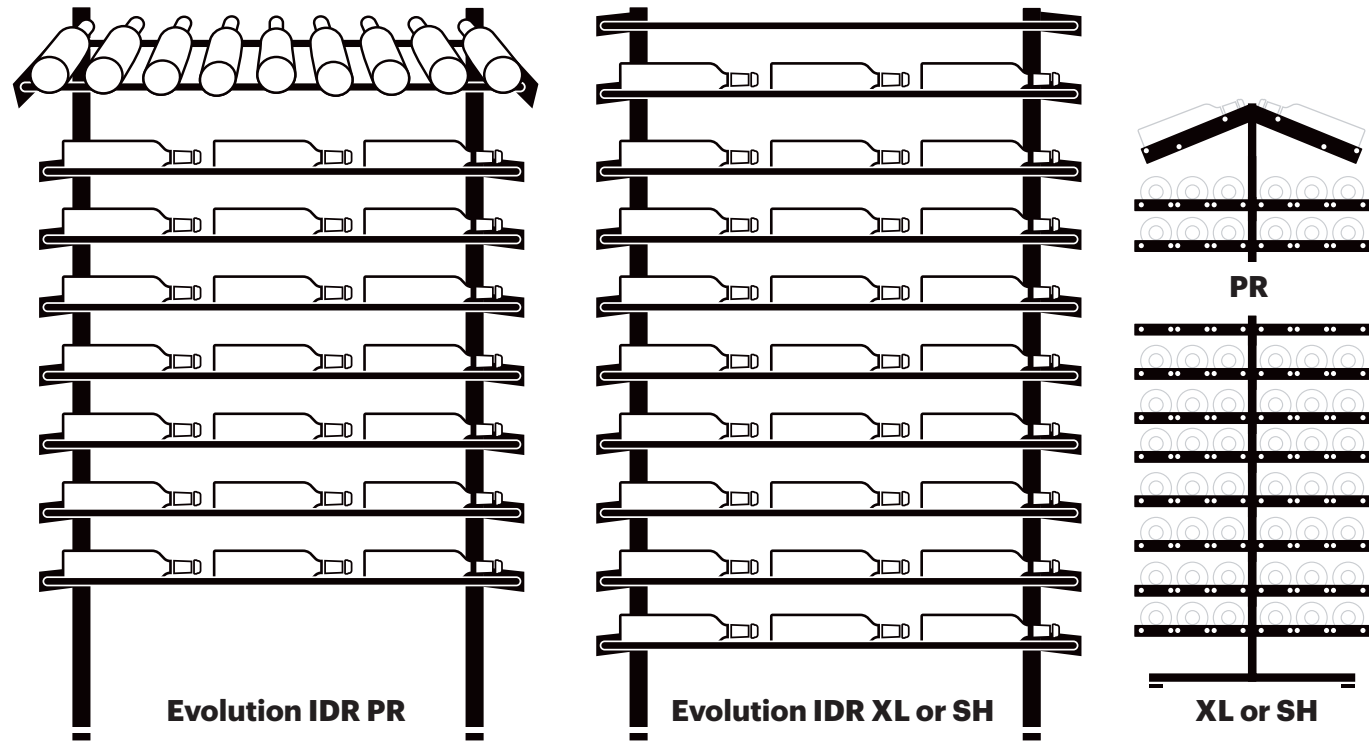

Wine Wall IDR3*				Wine Wall IDR4*			
	Width	Height	Bottles		Width	Height	Bottles
PR	41" (104.5cm)	44 3/4" (114cm)	54	PR	41" (104.5cm)	55 3/4" (142cm)	72
SH	41" (104.5cm)	44 3/4" (114cm)	63	SH	41" (104.5cm)	55 3/4" (142cm)	81
XL	41" (104.5cm)	44 3/4" (114cm)	72	XL	41" (104.5cm)	55 3/4" (142cm)	90

* all models available in two-sided units, which doubles bottle capacity

Modular Extensions Available Extension kits allow for modular growth of any IDR racking option.

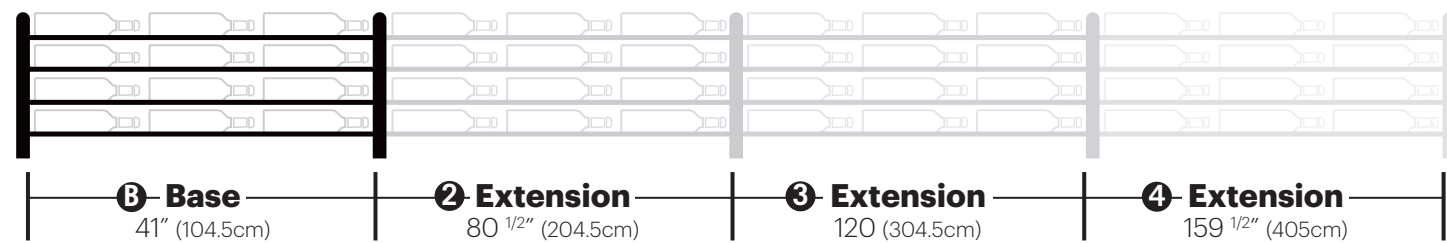

Finishes

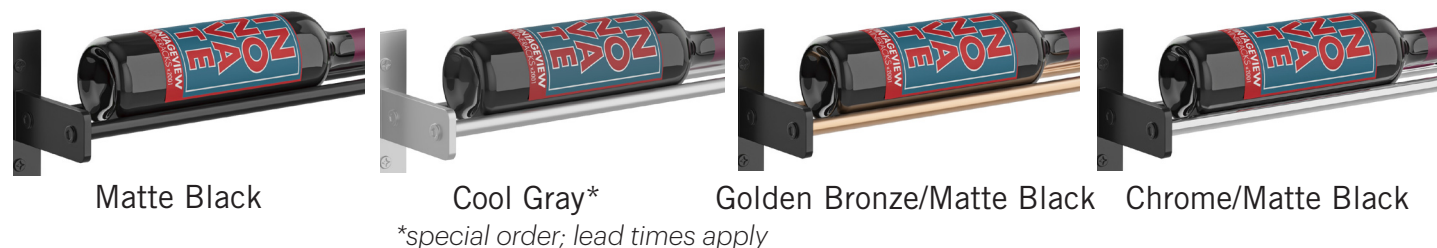

CASE AND CRATE

Upscale Locker or Bin storage for the largest bottle capacity requirements.

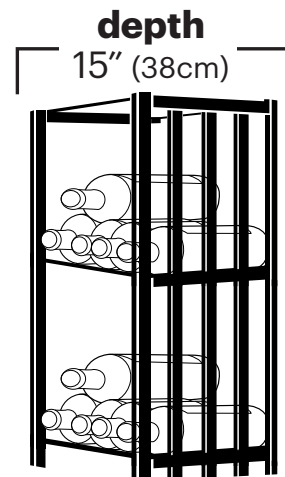
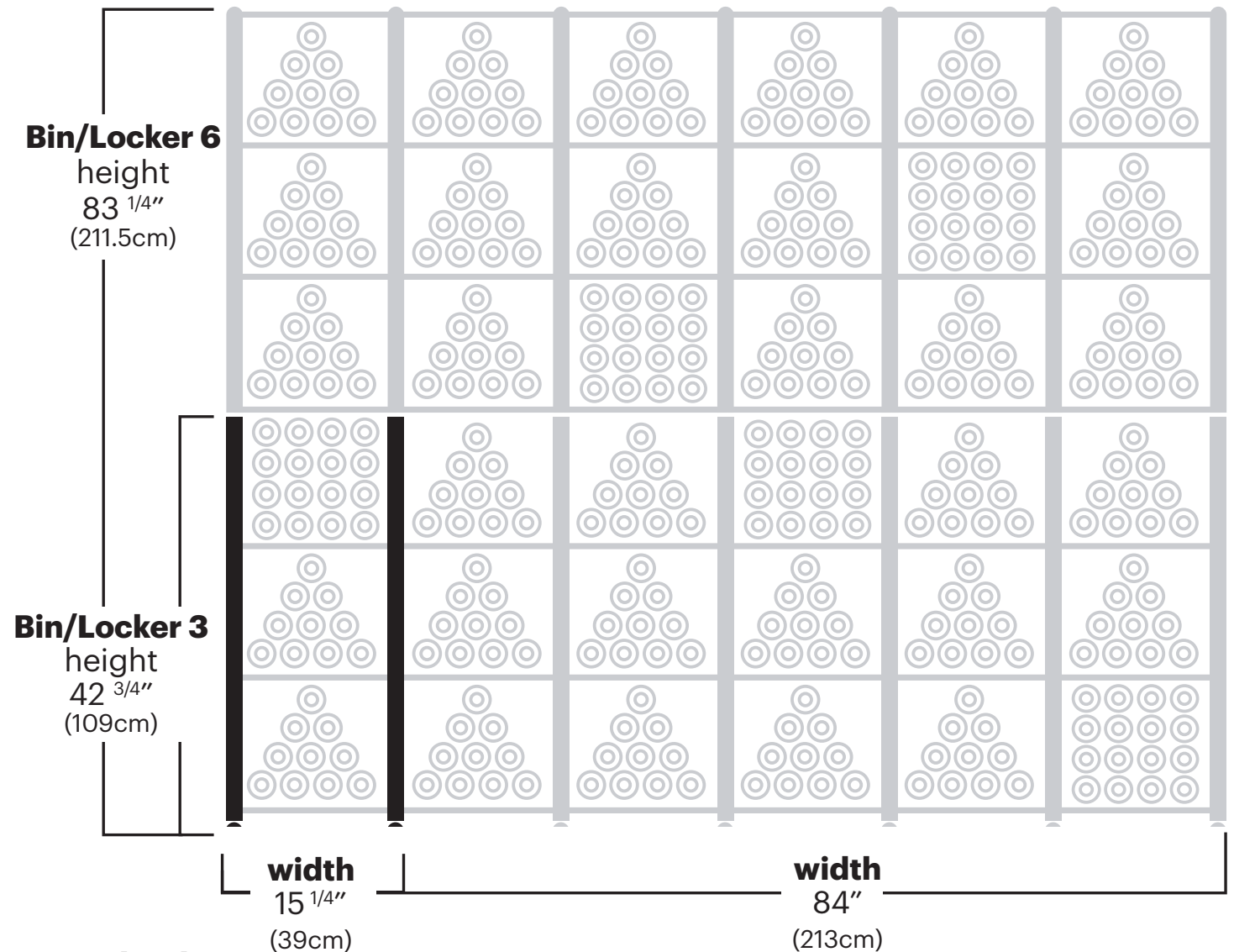

Model	Capacity*
Bin/Locker 3	48
Bin/Locker 3 w/1 ext	96
Bin/Locker 3 w/2 exts	144
Bin/Locker 6	96
Bin/Locker 6 w/1 ext	192
Bin/Locker 6 w/2 exts	288

*storing magnums decreases capacity

Finishes

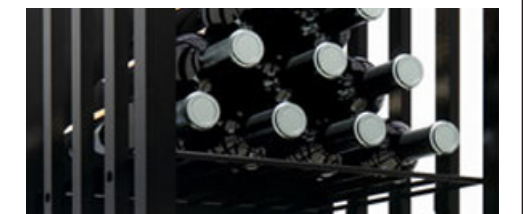

Matte Black

Figuring out which compelling mix of wine racks is best for your project is just the start. Our stellar service promise will ensure you receive the figurative white-glove treatment from the time an order is imagined to the day it's delivered.

Quick Fulfillment

We maintain a full warehouse of wine racking systems at our Denver headquarters, and our top notch team is shipping out most orders within a week's time.

Superior Quality

Our products undergo rigorous testing during development and a 15-point inspection upon receipt from our factory. We believe in the quality enough to back every single wine rack with a lifetime warranty.

Remarkable Service

Our team is made up of some of the most dedicated and passionate people in the industry, and we take pride in knowing that our customers appreciate the quality of service they receive when they order from us.

Tactful Training

Between our on-demand product training and Wine Cellar Design CEU (for AIA/IDCEC credit and available online, via webinar, or in person), we provide busy trade professionals with insane resources to improve the wine cellar building learning curve.

Inspiration in Person

Our state-of-art Design Center is open for the trade (by appointment only). Not in Denver? Take the virtual tour of the facility to see how well our systems look in context to beautiful design.

Expert Referrals

Need a general contractor, cooling expert, or full-service wine cellar builder? We have amazing partnerships in most major cities, including Canada and Europe. We love to play matchmaker.

We've long known our products are simple to install for most DIYers. Yet, there are some nuances that give folks pause. That's why we've teamed up with the BILT app to provide interactive 3D installation guides direct to your mobile or tablet device.

Whether you are a seasoned GC or a novice DIYer, this handy tool will turn you into a wine rack hero and have you confidently aligning and installing VintageView wine racks.

We also provide detailed specification sheets, written instructions, and video guides to ensure you have every resource to understand how our products work and where they fit.

- W Series Wine Rack
- W Series Wine Rack Frame System
- Vino Pins/Rails
- Vino Series Wine Rack Post System
- Evolution Low Profile Wine Rack System
- Evolution Wine Wall (coming later in 2023)
- Evolution Wine Wall Post System (coming later in 2023)

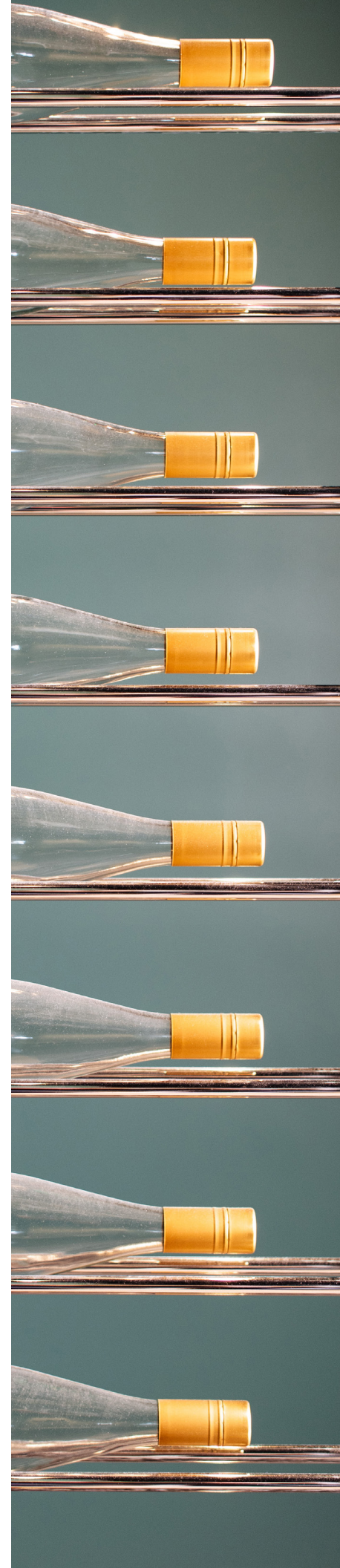



GET IN TOUCH

303-504-9463

VintageView Design Center
(appointment required)

4690 Joliet St., Denver, Co 80239

www.vintageview.com/design2023



Contemporary Cave

Helix Single Wine Rack (p52) and W Series Wine Rack Frame System (p50) 136 Bottles • Matte Black • Concept Room •
Design/Rendering: Roberto Valenzuela/VintageView